



CLEANROOM & LAB Solutions

Pharmaceutical • Biotech • Medical Device • Cleanroom • Lab • Research



Material Handling, Healthcare & Cleanroom Equipment

Phone: 1-800-441-8440 • F: 302-653-2065 • www.eaglemhc.com

CLEANROOM & LAB Solutions



single



double



cantilevered

Download
Gowning Racks
Spec EG04.01A

Gowning Racks - with Hanger Rail

These racks are designed for efficient storage of garments in the cleanroom. Available in stainless steel finish. The stainless steel construction offers a non-contaminating surface that eliminates particle shedding. 24" width, 73" height, and available in 48" to 84" lengths. Hanger slots are standard 2½" centers. Other center configurations are available.

Download
Wire Gowning Racks
Spec EG04.01B



hanger slots on
standard 2½" centers
(shown with optional hangers)

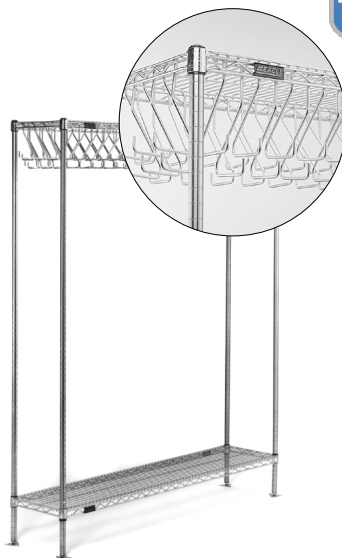

hooks welded on standard 1½" centers
on all four shelf sides

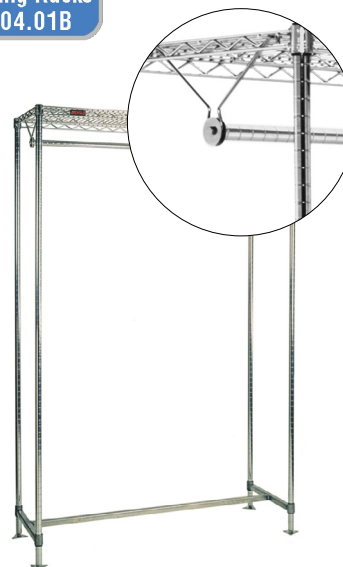

1"-diameter tubular bar
mounted underneath wire shelf

Gowning Racks - with Wire Shelving Components

patented
QuadTruss[®]
design

These racks incorporate standard wire shelving featuring patented QuadTruss[®] design, with specially designed gown storage options. They offer a more economical rack option in less demanding environments. Available in chrome-plated steel as well as stainless steel models. Available in 14" and 24" widths, and 48" to 72" lengths. 86" height.

CLEANROOM & LAB Solutions

Download
Wall Gowning Racks
Spec EG04.08

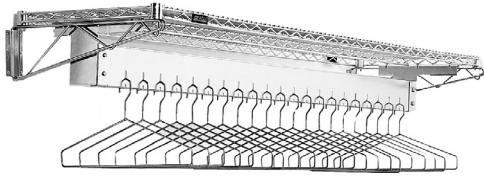

rack with hanger slots
(shown with optional hangers)

Wall-Mounted Gowning Racks 'Space Management Solutions'

Racks with Hanger Slots

This gowning rack is available in lengths of 48" [17 hangers], 60" [22 hangers], or 72" [27 hangers] and width of 24". Wall mounted, and includes open wire top shelf for laminar flow. Available in stainless steel finish or chrome finish. Hangers are optional.



rack with hanger tube

Racks with Hanger Tube

Like the freestanding model, this model features a 1" diameter tubular bar which mounts easily to underside of wire shelf and comes in width of 18" and lengths of 48", 60", and 72". Wire design facilitates laminar flow. Available in stainless steel finish or chrome finish.

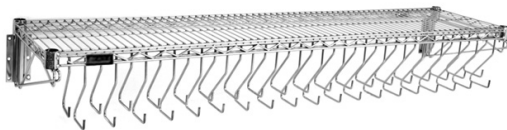

rack with hooks

Racks with Hooks

This compact design is 14" in width and comes in lengths of 48" [30 hooks], 60" [38 hooks] or 72" [46 hooks]. Available in stainless steel finish or chrome finish.

Hangers and Hanger Bar Kits

Open Loop Hangers

For all gowning rack models that employ hangers. Available in chrome finish, or stainless steel finish.



open loop hanger

Download
Hangers & HB Kits
Spec EG04.06

Closed Loop Hangers

For use with tubular gowning racks. Hangers are not removable from rack. Available in chrome finish, or stainless steel finish.



closed loop hanger

Slanted Hanger Bar Kits

Used to retrofit existing shelving into freestanding or wall-mounted gowning racks. Hanger slots on 2 1/2" centers. 24" shelf width required. Available in chrome finish, or stainless steel finish.



tubular hanger bar kits
(shown with optional hangers)



slanted hanger bar kits
(shown with optional hangers)

Tubular Hanger Bar Kits

Rack employs both closed loop hangers and open loop hangers. Available in chrome finish, or stainless steel finish. Width 18", and length ranges from 48" to 72".

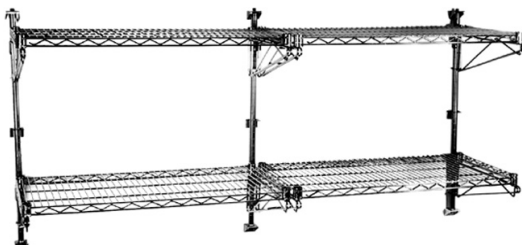

adjustable post wire wall mount systems
(shown with standard wire shelves)

Adjustable Post Wire Wall Mount Shelf Systems

Download
Wire Wall Mounts
Spec EG02.11

The adjustable wall mount provides wall storage and facilitates laminar flow. Use with standard wire shelves (sold separately). Designed to hold up to four tiers. The shelf widths range from 14" to 24" and the post height range from 14" to 63". Available in chrome and stainless steel.

CLEANROOM & LAB Solutions



solid gowning bench



heavy duty gowning bench with adjustable 4-sided frame



gowning bench with standard undershelf (shown with optional additional shelf and dividers)



wire gowning bench

Gowning Benches

Download
Gowning Benches
Spec EG04.03

Download
Heavy Duty Gowning
Bench Spec EG04.13

Solid Gowning Bench

Benches include flanged stainless steel foot plates for convenient attachment to the floor. Available in brushed 304 stainless steel finish. Widths of 9" and 12", lengths up to 84", and height of 17".

EL Series Heavy Duty Solid Gowning Bench

Heavy-duty benches feature hat channels on underside of seat. Stainless steel foot plates. 14 gauge type 304 stainless steel. 16" front-to-rear, lengths up to 96", and 17" height. Available with welded or adjustable h-frame, or with adjustable 4-sided frame.

Gowning Bench with Undershelf Storage

Available with perforated or solid seat. Wire undershelves offer optional bootie storage. These units come complete with designated seat, legs, foot plates, and one wire undershelf (additional wire shelves and dividers are optional). Available in stainless steel finish. Seating area is 18" wide, and wire unshelf is 14" wide. Length up to 72" and height of 19".

Wire Gowning Bench

Economical gowning bench with wire shelving components offers 62% laminar flow. Ideal for less demanding environments or for use during construction as the room is brought into clean. All units feature four 18" legs with foot plates, one three-sided channel frame, and one wire shelf. 14" width, 18" height, and available in lengths up to 72".

Carts and Wire Shelving Units

Open wire construction promotes higher visibility and permits greater air circulation, which reduces dust and contamination build-up. QuadTruss® design makes shelves up to 25% stronger. Posts are numbered on vertical 1" increments to ensure, fast, level assembly of shelves and maximum flexibility for unit/cart configuration. Numerous sizes and combinations are available. Accessories available include dividers, ledges, label holders, enclosure panels, and more.

two-shelf utility cart



patented
QuadTruss®
design



wire shelving unit



angled wire shelf cart



stainless utility carts

Stainless Utility Carts

Ideal for light- to medium-duty transport in virtually any environment. Three stainless steel shelves welded to angle legs and caster channel frame. Four 4"-diameter swivel plate casters. 1"-diameter handle on one end. Available with standard 1"-high upturn on ends and rear of top and center shelves, or 1"-high upturn on all sides of all shelves.

Download
Shelving Brochure
EG7014

CLEANROOM & LAB Solutions



PATENTED!
(Patent #7,992,731)

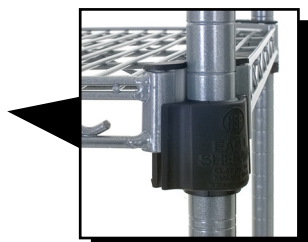

channel of shelf corner fits into slot of collar attached to split sleeve

Quad-Adjust® Wire Shelving

Add to your existing shelving without having to disassemble the entire unit.

- Shelves feature special interlocking corners that fit in slots of collars mounted to split sleeves, allowing addition or removal of a shelf without the need to disassemble the entire shelf unit.
- Tapered split sleeves create a positive lock that becomes stronger as the load increases.
- Leveling feet are provided to help compensate for uneven floor surfaces.
- Shelf utilizes a pincer-type design with the mat wire sandwiched between the two top truss wires, adding significant strength and distributing the entire load without stress and strain on the welds.
- Available in standard finishes.
- Accommodates standard wire shelving accessories.

Assembly is a simple 3-step exercise:



Step 1

Snap the split sleeves onto a post over the number of your choice.

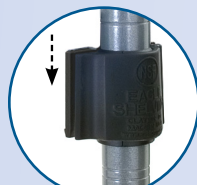

Step 2

Attach the QuadAdjust® slotted collar onto the split sleeves.



Step 3

Slide shelf into slotted collar to complete.



roll bag dispenser

Roll Bag Dispensers

Provides an effective means of dispensing rolls of bags or film. An easy way to establish protocol, by color of cleanroom waste, avoiding inadvertent mixing of non-compatible items. Standard unit consists of two 14" x 48" wire shelves, one 3-sided channel frame, eight removable dispensing bars and four 74" posts with 30" outrigger feet for stability. Dispensing bars are adjustable on 1" increments. Available in stainless steel or chrome finish. Unit measures 30" wide, 48" length, and 75" height. Custom sizes also available.

Download
Roll Bag Dispenser
Spec EG04.00

Security Units

Security units range from 17 1/4" to 33 1/4" in width, 33 1/4" to 63 1/4" in length, and 69" height. Ideal for storing and transporting valuable materials. Security units are offered in chrome or stainless steel finish. Stationary and mobile units available.



Download
Security Units
Spec EG01.22

full-size mobile security unit
—shown with optional
center shelf (sold separately)

CLEANROOM & LAB Solutions

QuadPLUS® Polymer Shelf Mats RFID-Compatible!

Download
QuadPLUS Shelving
Spec EG01.47

Easy Assembly!
No tools needed!

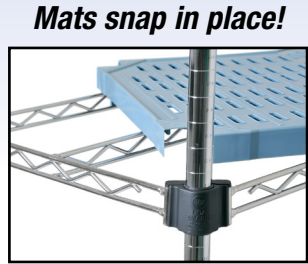

Mats snap in place!

removable shelf mats shown with Quad-Adjust® wire truss frame

polymer shelf mats available!

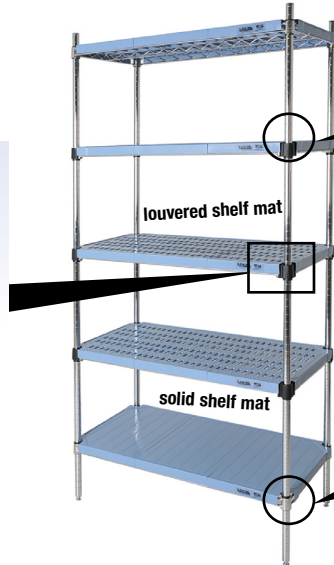

shelf mats—blue, louvered and solid —shown assembled to shelf unit

Mats come with choice of...



Quad-Adjust® Truss Frame...
Allows the addition or removal of a shelf without having to disassemble the entire shelf unit.



...or Standard Wire Truss Frame

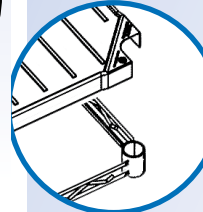

Step 1
Position polymer mats onto wire truss frame or shelf accordingly.

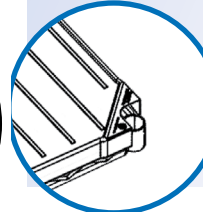

Step 2
Gently push each mat down along the front and rear to snap them into place.

NEW!

Gowning Dispensers

All units feature #4 brushed finish type 304 stainless steel construction. Compartment size and quantity can be customized to specific needs.

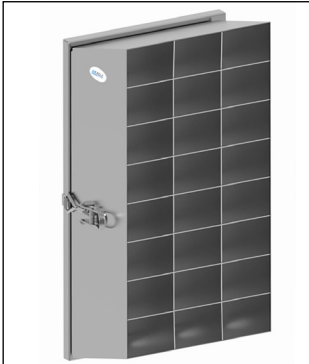

Eye Protection Holder

Compartments are sized for safety glasses and may be customized for goggles and other PPE. Compartments are 3⁵/₁₆" wide, 2⁵/₁₆" high, and 6¹/₂" deep.

Download
Spec Sheet
EG03.90



Garment Dispenser

Single compartment is sized for folded garments, such as scrubs, gowns, and aprons.

Download
Spec Sheet
EG03.91

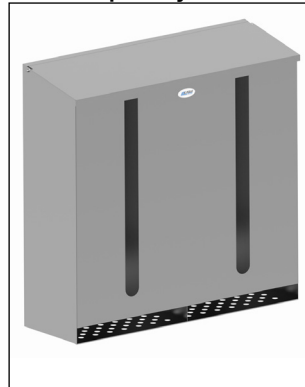

Packaged Glove Dispenser

Single compartment is 12¹/₄" wide, 22³/₈" tall, and 7³/₄" deep. Compartment is sized for folded garments, such as scrubs, gowns, and aprons. May be customized for specific sizes.

Download
Spec Sheet
EG03.92

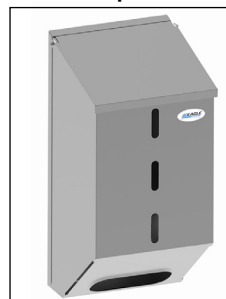

Loose Glove Dispenser

Single compartment is 8¹/₁₆" wide, 17" tall, and 8" deep.

Download
Spec Sheet
EG03.93

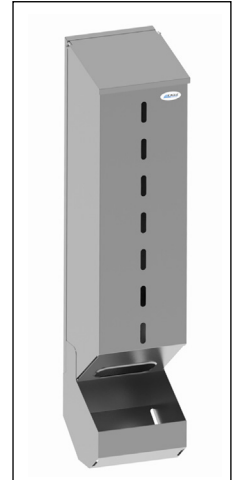

Loose Glove Dispenser with Catch Basin

Single compartment is 8¹/₁₆" wide, 39" tall, and 8" deep.

Download
Spec Sheet
EG03.93

NEW!

Laboratory Exhaust Canopies

Island or wall mount exhaust canopies feature 16 gauge type 304 stainless steel construction, fully welded seams, polished interior and exterior, steel rod suspension brackets, full perimeter condensation edge, 19" overall height, and integral duct collar. Exhaust canopies are available in 30" and 36" depths, and widths ranging from 36" to 96".



wall hood



island hood

Download
Laboratory Exhaust Canopies
Spec EG03.85

CLEANROOM & LAB Solutions



[Download
Stainless Inset
Casework Brochure](#)

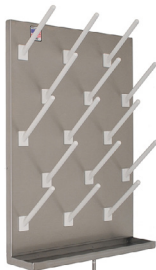

Stainless Steel Inset Casework

Eagle MHC manufactures a broad line of stainless steel inset casework featuring a wide variety of drawer and door confirmations to meet your laboratory requirements with all casework proudly made in the U.S.A.

Our comprehensive line of casework includes wall case, door base, drawer base, door/drawer combo bases, sink base, Tall case, pegboards, bench frames, and filler panels and strips.

Our casework construction and performance characteristics are in full compliance with SEFA 8M Metal standards.



Shoe Racks

[Download
Shoe Racks
Spec EG04.09](#)

Wire shelves offer the optimum combination of laminar flow and ventilation for the storage of cleanroom shoes. Rods and tabs run through the shelves to create cubbies for each pair of shoes. Optional snap-on plastic label holders are available for identification of each storage unit. Available finishes are chrome and stainless steel. Foot plates are included for fastening the unit to the floor. 14" width, ranging in lengths from 24" to 72", and up to 86" in height.

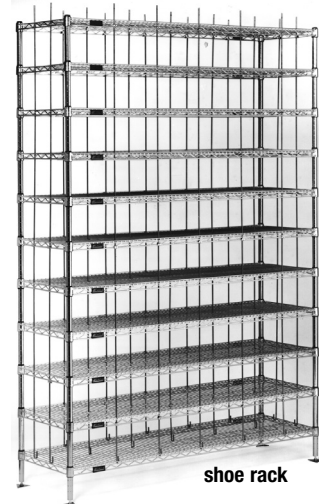
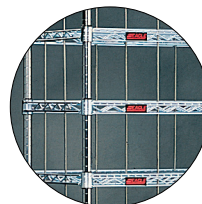

[Download
Vertical Storage
Cabinets EG04.11](#)

Vertical Storage Cabinets

All stainless steel type 304 enclosed cabinet with four adjustable interior shelves. Available with flat top or optional sloped top for laminar flow. Cabinets feature stainless steel hinged doors with wire-style pulls. Stationary units have stainless steel legs with adjustable bullet feet, while mobile units include 5"-diameter swivel/brake, stainless steel casters with poly tread. Options include glass doors, door locks, additional shelves and custom sizing.

CLEANROOM & LAB Solutions

Lab Benches

All stainless steel type 304 with #4 brushed finish. Available in adjustable height or fixed height models. Frame and leg constructed with 2" tubes. 16 gauge type 304 stainless countertop, 1" thick with square edge on all sides. Slotted rear uprights with two 16 gauge lab style shelves with 1.25" rear upturn, square edge front and upturned bookends. Designed to meet the SEFA recommended practices. Adjustable height and fixed height configurations available.



Adjustable Height Lab Bench

Download
Lab Benches-Adj. Ht
Spec EG03.82

Download
Lab Benches-Fixed Ht
Spec EG03.83



Fixed Height Lab Bench

AdjuTable® Work Surface Systems

Eagle's AdjuTable® System allows you to create work surfaces in the configuration of your choice. Each work surface system comes with four 33" posts and your choice of the following bases: two C-frames; two H-frames; one C-frame and one wire undershelf; or one H-frame and one wire undershelf. Work surfaces are stainless steel with either a solid or perforated design. Available sizes are 24" to 36" in width and 36" to 60" in length. Table bases are available in chrome or stainless steel. Optional keyboard, utility drawers, and casters are available.



Download
Adju Table Systems
Spec EG04.04A

adjuTable® Work Surface System

AdjuTable® Overshelf Systems

Eagle's AdjuTable® Overshelf System allows you to create work surfaces enhanced with two wire or cantilevered overshelves. Each work system comes with the two overshelves (two 29" posts come with wire overshelves only), two 33" front posts, two 63" rear posts, and your choice of the following table bases: two C-frames; two H-frames; one C-frame and one wire undershelf; or one H-frame and one wire undershelf. The available sizes are 24" to 36" width and 36" to 60" length. Work surfaces are stainless steel with either a solid or perforated design. Overshelves are offered in stainless steel or chrome finish. Optional keyboard, utility drawers, and casters are available.

Download
Adju Table Systems
Spec EG04.04B

Download
Adju Table Systems
Spec EG04.04C



C-frame AdjuTable® with wire overshelf system



C-frame AdjuTable® with cantilever overshelf system and optional drawer

Mobile Table with Flex-Master® and Drawer

A totally flexible system for both new and existing operations when versatility is needed. A unique custom-style overshelf system utilizing standard components. Unsurpassed style, strength, performance, and flexibility. Unlimited combinations of shelves and utility racks to meet any need—imagine the possibilities! Customize your table with an appropriate sink.

Download
Ht Adjustable Tables
Spec EG10.37

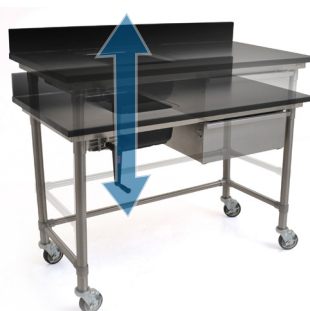

Height Adjustable Tables

For all of your ergonomic table needs. Tables adjust from 32" to 40" in height. The easy-to-adjust handle can be located at the left, right or center of the table. Available in 24" and 30" widths, and lengths ranging from 48" to 72". Tops are reinforced with stainless steel hat and leg channels, with Eagle's patented uni-lok® channel gusset system.

CLEANROOM & LAB Solutions

Download
Cleanroom Tables
Spec EG04.02

Cleanroom Tables

Type 304 stainless steel tables are available with a solid or perforated design. All perforated tops have $\frac{3}{8}$ " perforations on 1" centers, allowing for 40% laminar flow. Available in standard widths of 24", 30", and 36" and lengths from 36" to 96". Custom sizes available upon request. All cleanroom tables are alcohol-wiped and cleanroom bagged. Standard table bases are C-frame or H-frame in brushed or solid stainless steel undershelf.



Solid Top, C-Frame Base



Solid Backsplash Top with H-Frame Base



Solid Top with Undershelf



Perforated Top with C-Frame Base



Perforated Backsplash Top with H-Frame Base



Perforated Top with Solid Undershelf

Lab Workstations for Non-Critical Environments

Spec-Master® workstations feature a 14 or 16 gauge stainless steel top. All workstations are available with an adjustable stainless steel undershelf or tubular base. Left and right ends are turned down 90° providing a flat surface so tables can be placed end to end. Sound deadening insulation tape runs between hat channel and table top. All workstations feature our patented uni-lok® system which provides greater strength and a bullnose edge on front and rear (*without backsplash*).



SE series



SE-BS series



STE series



STE-BS series

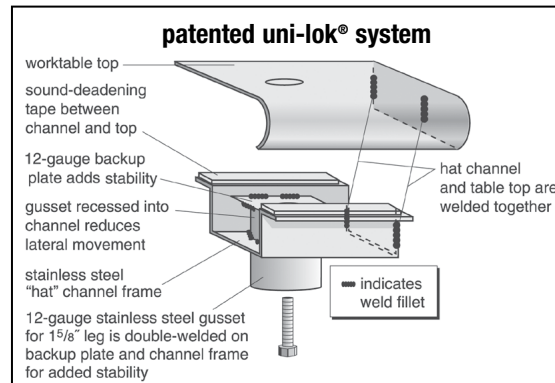

Download
Stainless Wkstations
Spec EG10.70

Foot Rests

Heavy gauge stainless steel all-welded construction. 1" square tubular welded frame, with non-slip rubber feet. Platform at 12° angle, removable for cleanability. Adjusts from 4 $\frac{1}{2}$ " to 9 $\frac{3}{4}$ " (lowest leading edge to the floor).



Foot Rest

Download
Foot Rest
Spec EG04.14

CLEANROOM & LAB Solutions

Download
Computer Wkstations
Spec EG01.04



mobile computer workstation with optional mouse shelf

Mobile Computer Workstations

Open wire workstation allows for laminar flow. Reduces moisture and dust build-up. Comes with standard keyboard drawer. Mouse shelf is optional. Available in chrome or stainless steel finish. 5" swivel casters (two with brake) with choice of resilient or polyurethane tread. 24" or 36" width, 24" or 36" length, 53³/₈" overall height.

Wire Workstations

Download
CR Workstations
Spec EG04.10

Stationary Workstations

Workstations with open wire construction offer 62% laminar flow with up to 800-lb. load-bearing capacity. Available in stainless steel or chrome finish. 24" width, and available in 36" or 48" length. Optional keyboard drawer available.

Mobile Workstations

Eagle's mobile workstations allow for easy relocation of stations as needed. Features four 5" poly stem casters (*two with brake*). Overshelves are height-adjustable in 1" increments for flexible and accurate placement without the use of tools. 24" width, and available in 36" or 48" length. Available in stainless steel or chrome finish. Optional keyboard drawer available.



stationary workstation



mobile workstation with two cantilevered overshelves

SpecFAB® Custom Capabilities



Custom Equipment Manufactured to Your Specifications!

Custom applications comprised of specially fabricated, stainless steel equipment or pre-fab modular components, or a combination of both, work their way quickly through a simple yet sophisticated design, approval and fabrication process. We can make multiple pieces with repeat precision. Equipment built to your exact specifications, pre-wired and pre-plumbed (if applicable), is shipped with shorter lead times and at a lower overall cost.



Manufacturing Capabilities:

- Engineering and design assistance.
- Room layouts provided.
- Standard and custom built stainless products.
- Small to large order capacities.
- Designed and built to industry standards.
- Quality controlled throughout process.
- In-house equipment capabilities and standard products provide economical solutions.

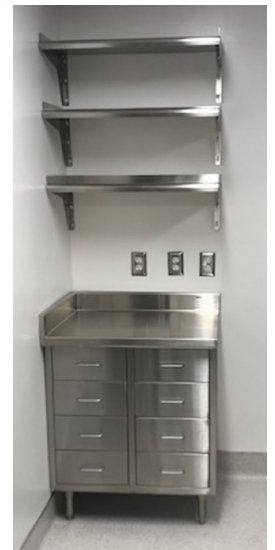

CLEANROOM & LAB Solutions

Lab Sinks

Constructed of 14 gauge type 304 stainless steel. Fully welded and polished bowls with radius corners. Rolled edges on front and sides, 8" high backsplash with downturn edges and mounting clips. Stainless legs, gussets and feet standard. Sinks available in one, two or three compartments with or without integral sloped drainboards.



3-bowl FN series sink with drainboards

Download
FN Series Sinks
Spec EG20.32-20.35



3-bowl lab sink with drainboards

Download
Lab Sinks
EG03.67-EG03.69

FN Series Sinks

14 gauge stainless steel throughout. All bowls are 14" deep and have 5/8" radius corners, both vertical and horizontal. Legs feature adjustable crossbracing front-to-back and side-to-side to increase stability. Standard 10" backsplash and include a 1" upturn. Sinks come standard in one, two, three, or four compartments with or without drainboards.



deep-drawn counter drop-in sink

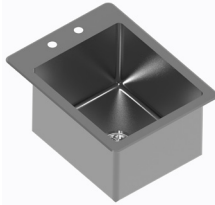

fabricated counter drop-in sink

Countertop Drop-In Self Rim Design Sinks

All units are 304 series stainless steel and come standard with mounting hardware, swivel faucet, and 1 1/2" basket drain. Available in one, two and three compartment. Deep-drawn and fabricated bowls available.

Download
Drop-In Sinks
Spec EG20.39A-B



3-bowl 314 Series sink

Download
314 Series Sinks
Spec EG20.27-20.30

314 Series Sinks

Deep drawn sinks have a generous radius and are rectangular for maximum capacity. Legs are galvanized, 1 1/2" diameter and welded adjacent to sink bowl for maximum stability and support. Sinks come standard in one, two, three, or four compartments with or without drainboards.



deep-drawn counter drop-in sink - no deck

Countertop Drop-In Sinks with No Deck

All units are 304 series stainless steel and come standard with 1 1/2" basket drain. Features 1 3/8" trim on all four sides. Available in one, two and three compartment. Deep-drawn and fabricated bowls available.

Download
Drop-In Sinks
Spec EG20.17A-B

Download
Hand Sink
Brochure

Hand Sinks

Eagle offers the widest range of hand sink choices with over 40 models to choose from - many available with exclusive Microgard® antimicrobial protection.

Eagle also offers the industry's only deep-drawn positive-drain bowl, assuring complete draining to meet even the most stringent health code requirements.

Hand sinks are type 304 stainless steel all-welded construction. Deep-drawn, one-piece, seamless bowls. Models vary from the traditional hand sink with faucet to the electronic hand sink with soap and towel dispenser and hot water heater. Available in wall mount and pedestal type models.



Stainless Steel Countertops

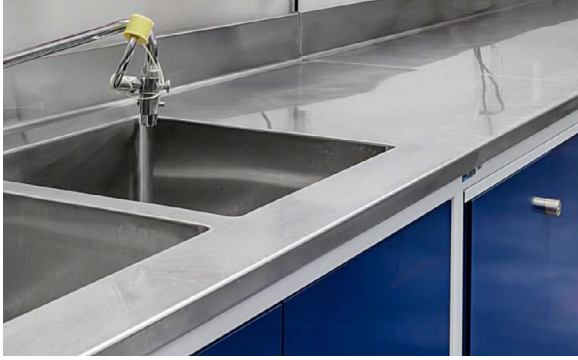

stainless steel countertops fabricated to drawings indicating backsplash height, raised edge and field condition requirements

Countertops

- 16 or 14 gauge, type 304 or 316 stainless steel available. Other gauges and types of stainless available to meet the function and chemical resistant demands of highly specialized labs.
- Standard front edge Square or Box Marine, unless otherwise specified.
- Back and end splashes are manufactured per specification. All working surfaces and sink bowls have covered sanitary horizontal and vertical corners.
- Either a mechanical hairline seam or field welded joint available per your specifications.
Maximum length without seam is 144". Length is reduced by 5½" for each end splash that may be required.
- Fabricated sink bowls available in most any size and depth with single or multiple compartments.
- For backsplash mounted faucets, splash will need to be at least 2" deep for plumbing access, holes for deck mounted faucets are typically centered 1½" from the edge of sink bowl.
- Both L-shaped and U-shaped tops are available per your drawings.
 - Corners are mitered and factory welded.
 - Maximum size without field joint provisions fits 101"H x 96"W trailers for ground shipment.
- Countertops have stainless steel reinforcing hat channels. NSF-listed sprayed latex sound deadening available upon request.
- Standard packaging is wood crated and is included in the cost.



Cleanroom/Lab Products



©2025 Eagle Group.

Although every attempt has been made to ensure the accuracy of the data in this publication, we cannot be responsible for printing or typographical errors or omissions.



Material Handling, Healthcare & Cleanroom Equipment

100 Industrial Blvd. Clayton DE, 19938
P: (800) 441-8440 • F: (302) 653-2065
www.eaglemhc.com



Rev 03/2025 EG7003